

Welcome to KENT

Dear Customer,

At the outset, allow us to thank you for your trust in **KENT Aura Air Purifier**. At **KENT**, we take pride in our reputation for product quality and industry proven performance. We are certain that your decision to own **KENT Aura Air Purifier** will go a long way towards keeping you and your family in good health. We are confident that you will be more than satisfied with its performance and that it will serve your need for safer and purer living without any compromise.

This guide would help you in getting the best out of your **KENT Aura Air Purifier**. Please go through the booklet to familiarize yourself with operation and maintenance.

You can look forward to years of trouble free service. To ensure that the warranty of your **KENT Aura Air Purifier** is effective, it is important that you fill up the enclosed warranty card and mail it to us within 15 days of purchase.

In case you require any further information, please contact your nearest **KENT** dealer/branch.

Happy Living,
KENT RO SYSTEMS LTD.

Table of Contents

1. Why KENT Aura Air Purifier	1
2. Salient Features of KENT Aura Air Purifier	1
3. Know Your Product	1
4. Items in the Box	1
5. HEPA Technology	2
6. Filtration Process	2
7. Setting up the KENT Aura Air Purifier	2-3
8. Using KENT Aura Air Purifier	4
9. Air Quality Indicator	5
10. Cleaning and Maintenance	6-7
11. Precautions	8
12. Important Safety Instructions	9
13. Troubleshooting	10
14. Technical Specifications	10
15. Spare Part List	10

Why KENT Aura Air Purifier

We, at KENT have always believed that clean and healthy living is the right of every individual. This ethos has made us embark on the journey to develop innovative solutions for cleaning water, fruits, vegetable and air. With the use of an innovative technology and supported by a competent service network, we have been able to create a brand which has become synonymous with well-being and health.

Continuing with the tradition, we now present the KENT Aura Air Purifier, with state-of-the-art HEPA Technology to provide clean and dust free air.

We all know that with every passing day, the air quality is worsening, but we are not aware that the air inside the house is equally polluted as the air outside. This high concentration of pollutants, especially dust particles, have adverse effects on our health.

Bacteria, dust, pollen, odours, hazardous gases (e.g., formaldehyde, benzene, etc.), soot, second-hand smoke, etc. are amongst the most common indoor pollutants. These pollutants have a high shelf life of up-to 240 hours in some cases. Inhaling these pollutants can lead to major complications like asthma, flu and other respiratory diseases.

On a day-to-day basis, a city dweller, spends almost 90% of the time indoor (either in office or at home), which means the quality of indoor air is critical to one's health.

We sincerely hope that KENT Aura Air Purifier will bring you and your family good health.

Salient Features of KENT Aura Air Purifier

1. HEPA (High Efficiency Particulate Arrestor) dust collection technology from Japan.
2. HEPA filter with Antibacterial coating.
3. High-efficiency removal of PM 2.5-Particulate Matter.
4. Activated Carbon Filter removes odour.
5. Improves air freshness with inbuilt Ionizer.
6. Intelligent Air Quality monitoring.
7. Filter change indicator.
8. Low noise operations.
9. User-friendly functional design, safe and convenient for use.
10. High purifying capacity, purifies air in the room instantly.
11. Suitable for a room area up-to 270 sq.-ft.
12. Child lock technology.

Know Your Product

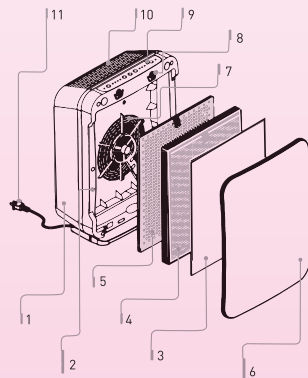

1. Back cover
2. Front panel button bit
3. Primary filter
4. Activated carbon filter
5. Antibacterial HEPA filter
6. Front panel
7. Fan
8. Air quality sensor
9. Operation panel
10. Air outlet
11. Power cord

Items in the Box

1. KENT Aura Air Purifier: 01 No.
2. User Guide: 01 No.

HEPA Technology

HEPA (HEPA stands for High Efficiency Particulate Arrestor) is a type of a mechanical air filter which removes 99.97% of particles less than 0.3 microns (micron is one millionth of a meter) in diameter from the air passed through it.

HEPA uses three different mechanisms (Impact, Interception and Diffusion) to catch and trap carcinogens particles, which are larger than 0.3 micron size and can be commonly found at homes such as dust mites, mold spores, pollen, pet dander and tobacco smoke.

These carcinogens particles have high shelf life and are highly injurious to health. They have been known to cause variety of health hazards like allergy, asthma and lung cancer. These particles cannot be removed by normal filters available in the market.

Filtration Process

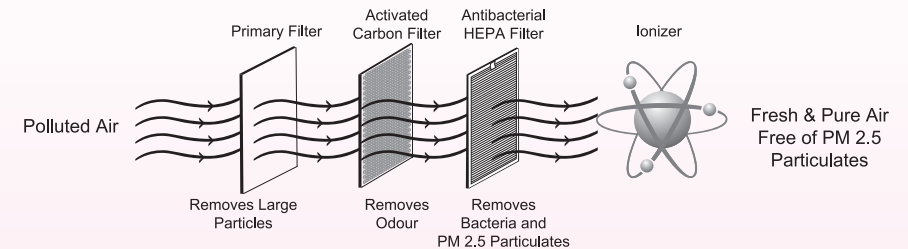

Setting up KENT Aura Air Purifier

Your KENT Aura Air Purifier is equipped with three filters for effective and efficient air filtration. Acting as a line of defense, each filter performs a customized role.

Filter 1: Primary Filter

The filter acting as the first line of defense, removes large and visible pollutants such as:

1. Large particles dust
2. Human and pet hair
3. Debris
4. Cobwebs



Primary Filter

Filter 2: Activated Carbon Filter

The activated carbon filter removes any smell/odour including:

1. Cigarette smoke (smell)
2. Foul odour
3. Pet smell
4. Formaldehyde
5. Benzene
6. TVOC

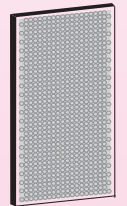

Activated Carbon Filter

Filter 3: Antibacterial HEPA Filter

The Antibacterial HEPA filters catches and traps various carcinogenic particles and pollutants such as:

1. Bacteria
2. Pollen
3. Allergens
4. Mould
5. Dust
6. Cigarette smoke particles



Antibacterial HEPA Filter

Installing Filters

This appliance comes with filters covered in plastic covering to prevent any wear and tear. This protective cover must be removed before using the appliance.

1. Unplug the appliance.
2. Put fingers in the groove at the upper part of the front panel.

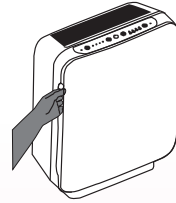

3. Gently pull and remove the front panel.

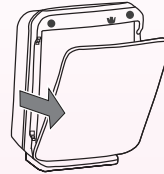

4. Remove filters from the product. Gently remove the protective plastic packaging.

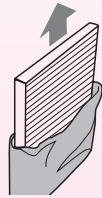

5. Place antibacterial HEPA filter. Please ensure the filters are installed in the correct order only.

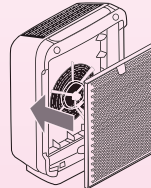

6. Place activated carbon filter followed by primary filter (maintaining the order) in the appliance, in correct position only.

Note: Antibacterial HEPA filter has to be installed in correct position. Failing to do so would hamper the purification process.

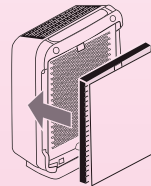

7. Before installing the front panel, ensure that all the filters are correctly placed.

8. To put the front cover on the air purifier, insert the snaps at the bottom of the front cover into slots, and push till you hear a click.



Using KENT Aura Air Purifier

1. Remove any stickers that can prevent unit operation.
2. Ensure that filters are installed in the correct format only.
3. Check the unit for damages. Do not use it in case of any damages.
4. Before switching the unit on, make sure that your home mains voltage corresponds to the unit operating voltage.
5. Once connected to the main power supply, the appliance will give out a single 'beep', indicating that it is ready for use.

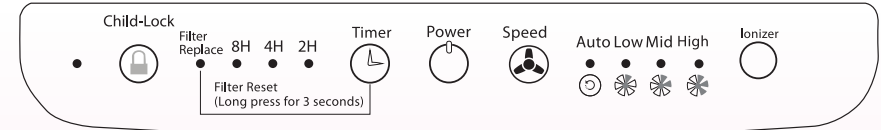

6. To start the KENT Aura Air Purifier, press 'POWER' button. The appliance will give out a 'beep' to indicate that it is on. The appliance would start in 'Auto-Mode' and with the ionizer turned on.
7. To turn off the appliance, press 'POWER' button.

Note: The appliance would start in auto mode each time it restarts in case of power failure.

Warning: To prevent any accidents and for your safety, the appliance would not start, in case the front cover is not properly placed.

Speed

KENT Aura Air Purifier comes with four different speed settings. These settings allow-Auto, low, medium and high. You to select a particular speed to suit your needs. To vary speed, press speed button on control panel.

1. For Low Speed-press speed button once.
2. For Medium Speed-press speed button twice.
3. For High Speed-press speed button thrice.



Timer

KENT Aura Air Purifier comes with three different timer settings-2 hours, 4 hours and 8 hours. These settings allow you to select a usage as per your needs.

To set timer, press timer button on control panel

1. To set timer for 2 hours-press button once.
2. To set timer for 4 hours-press button twice.
3. To set timer for 8 hours-press button thrice.

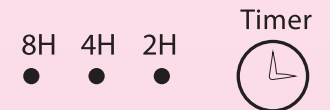

When the set time is up, the purifier will turn off.

Filter Reset

When 'REPLACE FILTER' LED glows, it indicates that the filters life is up and needs to be replaced.

The 'REPLACE FILTER' LED will glow after 2000 hours of usage in the normal course or when the filters are checked.

After replacing the filters, press and hold 'TIMER' button for 3 seconds to reset the 'REPLACE FILTER' indicator for filter replacement.

Note: The life of the filter indicated as 2000 hours, would depend on the quality of air being filtered.

Warning: It is important to reset the machine. Failing to do so might damage the photosensitive sensor.

Child Lock

To prevent any misuse, the appliance comes with a 'Child-Lock'. To activate Child Lock, press 'Child-Lock' key for 3 seconds. In this mode the operation panel would be in a lock state.

To cancel lock, long press 'Child-Lock' for 3 seconds. When the light turns off, all keys would be operating normally.

Child-Lock



Ionizer

The appliance comes with an inbuilt ionizer, which releases ions to freshen-up the air in the room.

Negative ions help freshen and purify the air by causing allergens such as pollen, mold spores, dust and animal dander floating in the air (which have either a neutral or a positive charge) to be attracted and stick to each other, forming 'Clumps'. Negative ions also have been shown to help lift mood, alleviate depression and seasonal affective disorder (winter depression or SAD). There is even a patent by a prominent researcher and institution for the treatment of depression with negative ions.



The ionizer starts automatically whenever the appliance is started with 'Auto Mode'.

Air Quality Indicator

Your KENT Aura Air Purifier comes with an inbuilt sensor and a display to indicate air quality in the room. The air quality is indicated by a glowing LED which also displays speed settings.

Once the appliance has been started, the air quality sensor requires around 3 minutes to initiate and would display pink colour only. After 3 minutes, the sensors display colour in accordance to the air quality in the room. The colour parameters are as described below:

Blue: Excellent

Pink: Good

Red: Poor

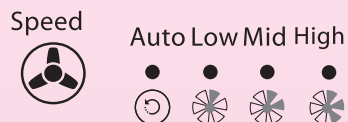

Note: In the first 3 minutes after the machine is turned on, the sensor stays in preheat stage, so the air quality indicating lights would display only pink colour. Any other air quality information is only for reference before it becomes stable.

Cleaning and Maintenance

To keep your KENT Aura Air Purifier spotless, please ensure a periodic cleaning of your purifier.

1. Switch off and unplug the appliance from the main power supply.
2. Regularly clean the appliance to prevent accumulation of dust. Wipe the appliance with a soft cloth to remove any dust or dirt.
3. In case of few stubborn marks, wipe with a soft cloth dipped in household detergent.
4. Do not use the machine till it is completely dry.
5. Do not clean the appliance by immersing it in water or holding under tap water. It might cause defects in the appliance.
6. Do not use cleaning agents, such as bleach or alcohol, that are corrosive or flammable.
7. The Air Quality Sensor needs to be cleaned once every 2 months to ensure excellent performance.
8. If the purifier is used in a dusty environment, please clean it regularly.

Cleaning Filters and Air Quality Sensor

To ensure optimum air quality and a longer product life, it is advised to clean Air Quality Sensor and Outer Filter on a periodic basis.

Cleaning Air Quality Sensor

Clean the Air Quality Sensor after every 2 months of usage. Gently brush (with a soft brush) the area around Air Quality Sensor as shown in the figure.

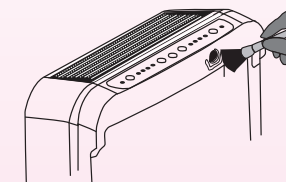

Cleaning of Filters

1. Primary Filter

Clean the Primary Filter after every 2 weeks of usage. Clean either with a vacuum cleaner or with the help of a soft brush.
2. Antibacterial HEPA and Activated Carbon Filter

Clean Antibacterial HEPA and Activated Carbon Filter once in every 2 weeks of usage.

 - a. To clean the filter, put it facing down on a newspaper or any other protective surface.
 - b. Clean the filters using a soft brush or vacuum cleaner (using brush nozzle or crevice nozzle) to remove the dust from its surface.
 - c. Do not exert any excessive force on the HEPA or Activated Carbon filter. Doing so might lead to its deformation.

Note: The filters should not be washed under any circumstances.

Replacement of Filters

When it's time to replace the filter, it would be automatically indicated by the appliance through flashing of the 'Filter Replacement Indicator'. When the 'Filter Replacement' LED starts flashing, replace the filter and reset the filter.

Put your fingers in the groove at the upper part of the front panel, and gently pull to remove front panel.

Note: Do not use excessive force. The front panel can be easily removed.

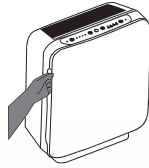

Removing Activated Carbon Filter and Primary Filter

Remove Activated Carbon Filter by holding its handle and pulling it out gently.

Note: Since the primary filter is fastened to the Activated Carbon filter, first remove the Activated Carbon filter followed by the primary filter.

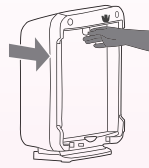

Remove Antibacterial HEPA Filter

To remove the antibacterial HEPA filter, hold the small handle on antibacterial HEPA filter, and pull gently.

Replace the filters by removing the new filter from its protective covering and install in the reverse order.

After replacing all the filters, plug the appliance to the main socket and restart it.

Note: After replacing the filters, press "timer" button to reset the filter. Hold till you hear three 'Beeps' indicating that the filters have been reset.

Warning: It is important that proper instructions are followed when cleaning or replacing of filter. Not adhering to proper procedures may impair the performance of the appliance.

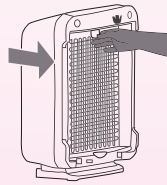

Precautions

1. Do not disassemble or repair the appliance on your own. Doing so may cause appliance failure or breakdown.
2. The input voltage must not exceed the rating as doing so might damage the appliance.
3. Unplug before replacing the filter/cleaning/moving the appliance.
4. Do not use the appliance with damaged power cord or plug.
5. If the supply cord is damaged, it must be replaced by the manufacturer, its service agent or similarly qualified persons in order to avoid a hazard.
6. Do not install the machine in a high humidity area, e.g., bathroom. The vapor may result in electric shock or breakdown.
7. Do not use the appliance in places with combustible liquids or heavy oil stain (e.g., machine oil). This may result in breakdown, electric shock or combustion.
8. Do not install the machine near any heat source, e.g., heater.
9. Do not use the appliance for soot ejection or for ventilation in kitchen. This would result in reduced service life of the filter and even the appliance might get damaged.
10. Do not stick fingers or any other objects into the air outlet.
11. When using pesticide, turn off the appliance to prevent any chemical from being sucked in. The chemicals may accumulate in the machine and generate hazardous pungent substance under certain circumstances.
12. When the machine is used together with a humidifier, prevent excess water vapor from entering into the machine, because water vapor could lead to electric shock and damage the machine.
13. Do not block the air intake and outlet, which may otherwise reduce the machine's cleaning capacity (the indoor air may not be cleaned thoroughly) and result in machine breakdown.
14. Do not place the appliance near any water source such as fish tank or vase. If water enters into the machine, it may cause electric shock or malfunction.
15. If the machine is not being used for a long time, unplug it.
16. Do not sit, stand or shake the appliance.
17. Do not use the machine when it is in a recumbent or inclined position.
18. Do not use the machine to remove any toxic substance, e.g., CO.
19. Do not use the machine at heavily smoky or dusty place, e.g., kitchen or where flammable gas, caustic gas or metal dust may have access. This might cause fire or failure.
20. Always use Kent Genuine Spare Parts for effective purification.
21. Children should be supervised to ensure that they do not play with the appliance.
22. This appliance is not intended for use by persons (including children) with reduced physical, sensory or mental capabilities, or lack of experience and knowledge, unless they have been given supervision or instruction concerning use of the appliance by a person responsible for their safety.

Important Safety Instructions

When using an electrical appliance, basic precaution should always be followed, including the following:

1. Unplug, when not in use and before servicing.
2. To reduce the risk of electric shock, do not use on or near wet surfaces.
3. Use the appliance only as described in the manual.
4. Do not use the appliance, if cord or plug is damaged or worn out. Replace the damaged cord or plug immediately.
5. Do not try to service the appliance on your own. Send it to KENT authorized service center only.
6. Keep cord away from heated surfaces.
7. Do not unplug the appliance by pulling the cord. Always unplug by pulling the plug and not the cord.
8. To avoid electric shocks, do not use the appliance with wet hands.
9. Keep hair, loose clothing, fingers and all parts of body away from moving parts.
10. Turn off all controls before unplugging.
11. Never use the appliance without the filter in place.
12. This appliance is suitable for indoor use only.
13. Do not put the product directly under an air-conditioner, to prevent condensation of water droplets in the appliance.

Warranty Card

(For Sale through Dealer)

Product : **KENT AURA AIR PURIFIER**

Serial No. :



Customer Details

Customer's Name _____

Customer's Address _____

Customer's Ph. No. _____

Warranty Details

Invoice Date _____ Invoice No. _____

Date of Installation _____ Stamp of Service Provider _____

For Service Contact

Service Provider's Name _____

Service Provider's Address _____

Ph. No. _____

Marketed by: **KENT RO SYSTEMS LTD.**
E-6, 7 & 8, Sector-59, Noida, U.P.- 201 309, India.
Ph.: +91-120-3075000
E-mail: service@kent.co.in | Website: www.kent.co.in
Call: 092-789-12345

Terms & Conditions of Warranty

KENT warrants all new products manufactured by it to be free from defects in material and workmanship under normal usage and service from the date of purchase as under:

- The Warranty period commences from the date of purchase by the first end-user. During this Warranty period of one year, KENT or its Authorized Service Provider (ASP) will replace or repair any part of KENT AURA AIR PURIFIER, that in the opinion of KENT or its ASP, would be defective in operation due to faulty material or workmanship (i.e. manufacturing defects) with the exception of consumables such as filters.
- The product's plastic body is not covered under Warranty and hence, it must be handled with care to guard against breakage.
- The original purchaser of the unit can avail services under Warranty at the point of sale, by producing the damaged part(s) along with the original invoice.
- This Warranty is void if the unit is not operated under normal conditions or according to the instructions given in the manual.
- Product returned to KENT or its ASP for Warranty examination must be shipped freight prepaid.
- KENT or its ASP shall not be held liable for claims exceeding the cost of repair of the defects in workmanship.
- This Warranty Agreement shall not be interpreted to render KENT or its ASP liable for injuries or damages of any kind - direct, consequential or contingent to persons or property.
- KENT or its ASP shall not be held responsible by representative or buyer for failure to abide by any of the obligations of this Warranty Agreement if such failures are the result of circumstances of Forces Majeures: such as, but not limited to, floods, earthquakes, transportation strikes, labour disputes with outside suppliers or any other conditions beyond the control of KENT or its ASP.
- KENT or its ASP shall not be held liable for repair or alterations made without prior written approval; for products failures resulting from the lack of proper maintenance.
- This Warranty Agreement excludes all products/component parts or damage to any part of this air purifier which, in the opinion of KENT or its ASP, have been subjected to misuse; misapplication; negligence; alteration; accident or operation contrary to our instructions, incompatibility with accessories not installed by KENT or its ASP, or that have been repaired with component parts other than those manufactured by or obtained from KENT or its ASP. Damage caused by freezing, flood, fire or Act of God is not covered by this Warranty. In all such cases regular charges will apply. This limited Warranty does not include service to diagnose a claimed malfunction in this unit.
- KENT reserves the right to alter or improve design and specifications at any time, without any contingent obligations to prospective buyers or owners of the products previously sold.
- Any disagreements and obligations based upon the purchase of KENT products and thereby imposed on KENT or its ASP shall be governed by and construed according to the laws of INDIA and subject to the jurisdiction of Delhi Courts only.
- KENT or its ASP assumes no Warranty liability in connection with this air purifier other than that specified herein. This Warranty is in lieu of all other warranties, expressed or implied, including warranties of fitness for a particular purpose. KENT or its ASP does not authorize any person or representative to assume for them any other obligations on the sale of this air purifier.
- Under no circumstances, the liability of KENT or its ASP shall exceed the value of the product.
- Under no circumstances are the terms mentioned above negotiable and no employee of KENT or its ASP has the authority to supersede them.

Trouble Shooting

Problem	Possible Cause	Possible Solutions
The Appliance does not switch on	<ul style="list-style-type: none"> Power Cord not firmly plugged into socket No power in the main supply 	<ul style="list-style-type: none"> Plug the unit firmly Check the fuse or cutout switch Replace fuse or reset the switch Install Front Panel properly Call KENT authorized service center
Air not coming out	<ul style="list-style-type: none"> Air intake or outlet is blocked Protective plastic packaging has not been removed 	<ul style="list-style-type: none"> Change the position or remove the blockage Remove plastic packaging
	<ul style="list-style-type: none"> Motor doesn't work 	<ul style="list-style-type: none"> Call KENT authorized service center
There is no effective purification	<ul style="list-style-type: none"> The machine is installed at a poorly ventilated place or there is an obstacle nearby 	<ul style="list-style-type: none"> Remove the obstacle
	<ul style="list-style-type: none"> Antibacterial HEPA/Activated Carbon/Primary Filters are overused and require replacement 	<ul style="list-style-type: none"> Replace Antibacterial HEPA/or Activated Carbon/ Primary Filters
Foul odours coming from the Air Purifier	<ul style="list-style-type: none"> The foul odours may be due to excessive smoking in a shorter interval of time 	<ul style="list-style-type: none"> The odours will disappear after a while
	<ul style="list-style-type: none"> Antibacterial HEPA/Activated Carbon/Primary Filters are overused and require replacement 	<ul style="list-style-type: none"> Change Antibacterial HEPA/Activated Carbon/Primary Filters

Technical Specifications

Model Name	KENT AURA AIR PURIFIER
Model Number	15002
Mounting	Pedestal
Net Weight	5.00 kg
Input Power Supply	Single Phase 220-240 V, AC 50/60 Hz. <input type="checkbox"/>
Product Dimension (mm)	350 (L) X 180 (W) X 482 (H)
Effective Room Area	Upto 270 sq.ft.
Noise (dB)	<= 60 dB (A)
CADR (Clean Air Delivery Rate)	180 m ³ /h
Power Consumption	45 W

Spare Part List

Replacement of spare parts are as under:

- Primary Filter
- Antibacterial HEPA Filter
- Activated Carbon Filter

Note: The filters are consumables. Their replacement time depends upon the quality of air being purified. They are not covered under warranty.