

AIR PURIFIER

IMPORTANT SAFETY INSTRUCTIONS

For Model AKJ050GE-CA

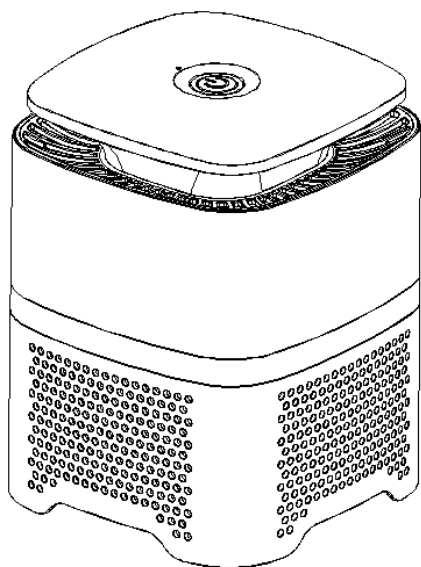

READ AND SAVE THESE SAFETY INSTRUCTIONS BEFORE USING THIS AIR PURIFIER

TABLE OF CONTENTS

SAFETY INSTRUCTIONS	1
PRODUCT BENEFITS	2
MAIN PARTS.....	3
OPERATING THE AKJ050GE-CA AIR PURIFIER	5
POWER ON AND SPEED SETTING.....	5
IONIC FUNCTION.....	5
FLITER CHANGING REMINDING	5
CLEANING & MAINTENANCE	6
CHANG HEPA FILTER.....	6
CLEANING THE HOUSING	7
TROUBLE-SHOOTING.....	7

READ AND SAVE THESE INSTRUCTIONS

WARNING: RISK OF ELECTRICAL SHOCK

Safety precautions should always be used when operating this or any electrical appliance. Decrease the risk of electrocution, electric shock, injury or fire by reading and following all the warnings below.

Use only as described in this AKJ050GE-CA manual. To reduce the risk of electric shock, do not attempt to service the product in any way other than in the manner described in the "Cleaning & Maintenance" section of this manual.

READ ALL INSTRUCTIONS BEFORE OPERATING THE AIR PURIFIER.

- » This machine is only for home use, not used for commercial and industrial purposes
- » This appliance can be used by children aged from 8 years and above and persons with reduced physical, sensory or mental capabilities or lack of experience and knowledge if they have been given supervision or instruction concerning use of the appliance in a safe way and understand the hazards involved. Children shall not play with the appliance. Cleaning and user maintenance shall not be made by children without supervision.
- » This product operates at 100-240V, 50/60Hz only.
- » The method, frequency of cleaning, and necessary precautions to be taken;
- » Read the maintenance instructions before opening the appliance.
- » Do not run cord under carpeting. Do not cover cord with throw rugs, runners, or similar coverings. Arrange cord away from traffic area and where it will not be tripped over.
- » Do not operate the product in any greasy environment, such as in the kitchen. This product is not intended to filter oil or grease from the air.
- » Do not use the AKJ050GE-CA air purifier in bathrooms or other humid environments. Do not use near fireplaces or in areas where flammable or combustible vapors or products may exist.
- » Always unplug the power cord from the electrical outlet when the purifier is not in use, before cleaning, inserting or removing parts or before moving to another location.
- » Never run the air purifier unless it is fully assembled.
- » This appliance has a polarized plug (one blade is wider than the other). To reduce the risk of electric shock, this plug is intended to fit in a polarized outlet only one way. If the plug does not fit fully in the outlet, reverse the plug. If it still does not fit, contact a qualified electrician. Do not attempt to defeat this safety feature.
- » Always turn off all controls before unplugging the AKJ050GE-CA air purifier from the outlet.
- » Attempting to service the AKJ050GE-CA air purifier in any way that is not described in this owner's manual will cause the warranty to be voided and could cause serious personal injury to the user and/or result in considerable damage to the unit.
- » Do not place the cord near a heated surface.
- » If the supply cord is damaged, it must be replaced by the manufacturer, its

service agent or similarly qualified persons in order to avoid a hazard.

- » Never use the power cord to pick up, carry, drag, pull, or lift the AKJ050GE-CA air purifier. Do not pull the cord against or around sharp corners and edges. This could result in injury to the user or damage to the cord.
- » Always remove the plug from its power outlet by holding onto the plug itself and pulling gently.
- » Never pull on the cord itself to unplug it from its power outlet.
- » Use care when operating the AKJ050GE-CA air purifier by keeping all foreign objects, fingers, body parts, hair, loose clothing and jewelry away from openings.
- » Never touch the AKJ050GE-CA air purifier or its plug when your hands are wet.
- » The AKJ050GE-CA air purifier is an electrical appliance. Adult supervision is required when operating the AKJ050GE-CA in the presence of children.
- » To reduce the risk of fire or electric shock, do not use this air purifier with any solid-state speed control devices.
- » Never modify the appliances .Use only the attachments and accessories recommended by the manufacturer.

PRODUCT BENEFITS

» **4 - Stage purification process:**

- 1 Pre Filter.
- 2 HEPA Filter.
- 3 Active Carbon Filter
- 4 ION boost.

» **2 speed fan setting—lets you select the desired cleaning level.**

» **360° inlet supply enough wind flow.**

» **More than 3million/cm³ ION makes the air more pure and fresh.**

» **Filter Changing Reminding.**

SPECIFICATION

Model No. : AKJ050GE-CA

Input Voltage : AC100~240V

Frequency : 50~60Hz

Output Voltage : DC12V

Rated Power : 3.6W

Coverage Area: 5m²

Product Size: 170mm X 170mm X 216mm

Product Weight: 1.1Kg

MAIN PARTS

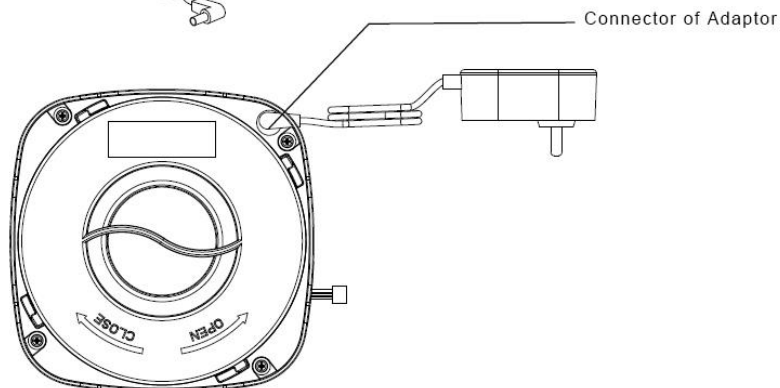
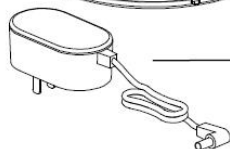
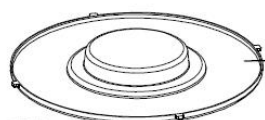
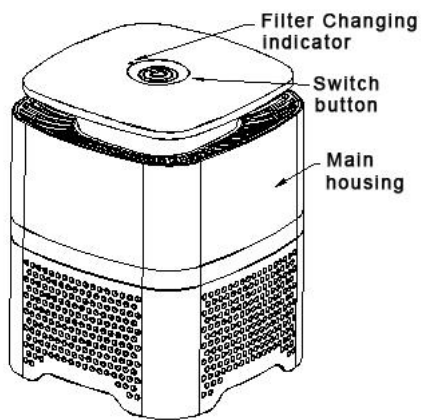



OPERATING THE AKJ050GE-CA

1.Connect the power supply

Insert the output end of supplied adaptor into the connector on the bottom of air purifier(see Picture 3),make sure the filter and the bottom cap is fully assembled ,then put the air purifier on flat surface like desk,plug the adapter into the power outlet.

WARNING:To make sure safety operation of the air purifier,please always use the supplied adaptor to avoid any accident or injure.

2.Turn on/off and settings

After plug in,the air purifier turn to status of Standby (the indicator in red color).Press one time of the switch button,the air purifier turn to low speed(the indicator in light blue color).Press again the button,the air purifier turn to high speed(the indicator in dark blue color).Press again the button,the air purifier turn off with standby status.

WARNING:Please cut off the power supply if the air purifier would not been used for long time.

3.ION function

The ion generator inside provide millions ions,it will be turn on automatically when the air purifier is operating at low speed or high speed,and it will be turn off when the air purifier is on standby status or power off.

4.Filter Changing Reminding

The Change Filter Indicator Light will flashing each time the filter needs to be cleaned or changed.

CLEANING & MAINTENANCE

WARNING: Always make sure the AKJ050GE-CA is turned off and unplugged before cleaning.

1、 Change the HEPA filter

- ✚ Rotate the bottom cap anticlockwise to the opening and take detach the bottom cap(see picture 1)
- ✚ Take out the used HEPA filter ,change to new filter and insert into the air purifier according to the direction as picture 2
- ✚ Cover the cap and rotate it clockwise till you can hear the sound of click,and the cap would be closed.
- ✚ Use toothpick or something similar to press the “filter changing indicator” for 3 seconds,the indicator would flash 3 times,the buzzer would sound 3 times,which means the filter reset successfully.The air purifier can be operated normally after plugged in.

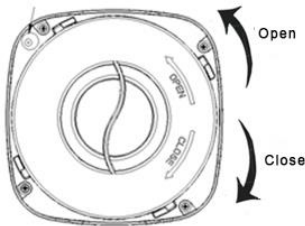

Picture 1

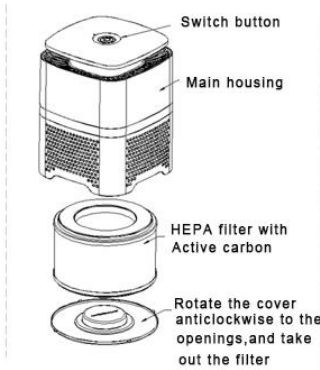

Picture 2

Press for 3 seconds to reset the filter reminding

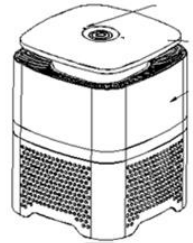











Picture 3

2、 Clean the surface of housing

- ✚ Turn off the air purifier and unplugged the adaptor.
- ✚ Use soft cloth with little soap water to clean the surface of housing.
- ✚ Please make sure the water would not flow into the air purifier ,otherwise it may damage your air purifier and lead to electric short and injure.
- ✚ Place the air purifier somewhere well ventilated,never expose to the sun directly,only turn on the air purifier when it is thoroughly dry.

TROUBLE SHOOTING

Problem	Possible Reason	Solution
 The standby indicator light do not display after plugged in.	 1.The adaptor is not well connected with the air purifier.  2.The adaptor is damaged.	 1.Check again the connection on the bottom and make sure they are connected.  2.Buy the original adaptor from the service center.
 When switch to high speed,the output of wind flow is very low or even no wind come out	 1.There is something shelter on the outlet  2.The circuit has some problem	 1.Clear out the shelter  2.Contact service center for maintaining